

Pulsation Dampener



To Purchase:

- 800-990-7867
- sales@yamadapump.com
- Find My Rep

More Information:

- YouTube: @yamadapump
- yamadapump.com
- Data Sheets | CAD Drawings | Manuals Literature | BOM | Performance Curves

Trial Program



REF. NO.	PART NO.	DESCRIPTION	QTY.	REORDER
1	713306	AIR CHAMBER	1	
2	771316	CUSHION	1	
4	711902	CENTER DISK	1	
5	771701	DIAPHRAGM	1	
6	611204	BOLT	6	
7	631015	PLAIN WASHER	6	
8	631918	WAVE WASHER	6	
9	627014	NUT	6	
10	714096	FLANGE OUT	1	
11	640065	O RING	2	
12	795080	VALVE	1	
13	716407	VALVE SEAT	1	
14	802569	MUFFLER	1	
16	630241	EYE NUT	1	
17	640017	O RING	1	
18	710717	NUT	1	
19	710719	NUT	1	

REF. NO.	PART NO.	DESCRIPTION	QTY.	REORDER
20	681170	MUFFLER	1	
21	714085	UNION	1	
22	710727	SPRING	1	
23	713442	CENTER ROD	1	
24	773092	THROAT BEARING	1	
25	630807	RETAINING RING	1	
26	714095	FLANGE IN	1	
27	713322	STUD	4	
28	631014	PLAIN WASHER	8	
29	631917	WAVE WASHER	8	
30	686250	BOLT	8	
31	683408	NUT	1	
32	682740	CONED DISK SPRING	1	
33	713369	CENTER DISK	1	
34	713156	OUT CHAMBER	1	
35	627013	NUT	4	

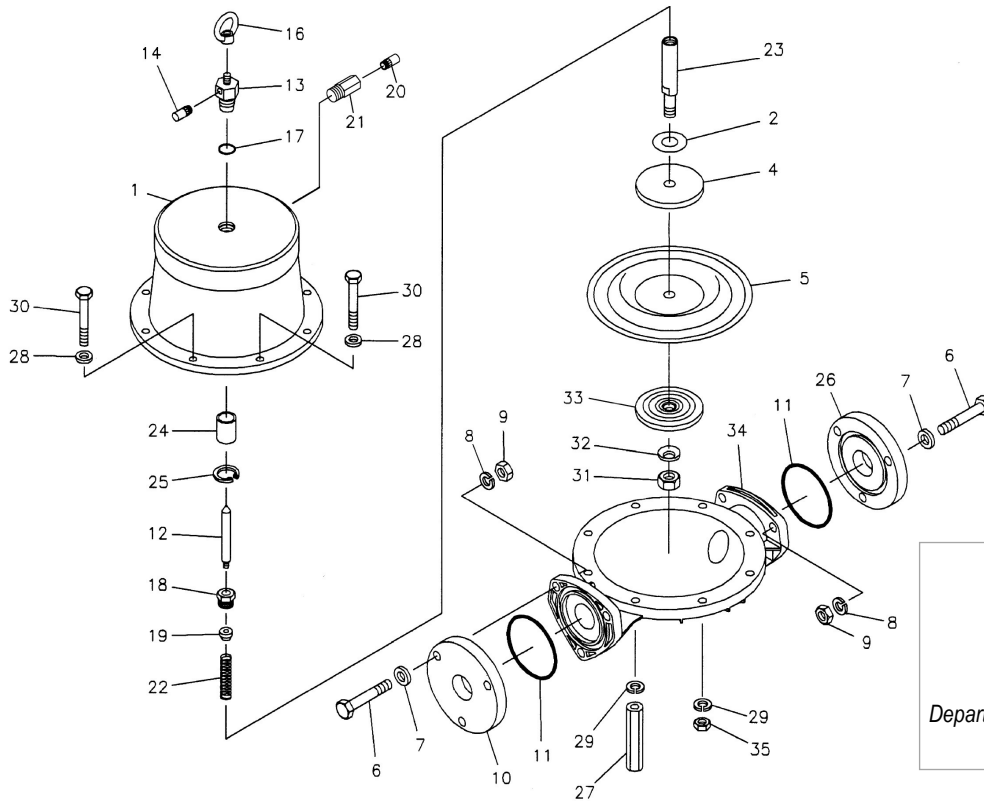

**Customer Notes**

Model #: \_\_\_\_\_

Description: \_\_\_\_\_

Serial #: \_\_\_\_\_

Date Installed: \_\_\_\_\_

Department Location: \_\_\_\_\_

Tag/Project: \_\_\_\_\_